



TAI-SAW TECHNOLOGY CO., LTD.

No. 3, Industrial 2nd Rd., Ping-Chen Industrial District,
Taoyuan, 324, Taiwan, R.O.C.

TEL: 886-3-4690038 FAX: 886-3-4697532

E-mail: tstsales@mail.taisaw.com Web: www.taisaw.com

Product Specifications Approval Sheet

Product Description: Band 41 SAW Filter 2605 MHz SMD 1.4x1.1 mm (BW=100 MHz)

TST Part No.: TA1964C

Customer Part No.: _____

Customer signature required
Company: _____
Division: _____
Approved by : _____
Date: _____

Checked by: _____ Hayley Chou *Hayley Chou*

Approved by: _____ Andy Yu *Andy Yu*

Date: _____ 2017/03/09

1. Customer signed back is required before TST can proceed with sample build and receive orders.
2. Orders received without customer signed back will be regarded as agreement on the specifications.
3. Any specifications changes must be approved upon by both parties and a new revision of specifications shall be released to reflect the changes.



TAI-SAW TECHNOLOGY CO., LTD.

No. 3, Industrial 2nd Rd., Ping-Chen Industrial District,
Taoyuan, 324, Taiwan, R.O.C.

TEL: 886-3-4690038 FAX: 886-3-4697532

E-mail: tstsales@mail.taisaw.com Web: www.taisaw.com

SAW Filter 2605 MHz

MODEL NO.:TA1964C

REV. NO.:1

A. MAXIMUM RATING:

1. Input Power Level: 28.5 dBm, 5000h 55 deg.C
2. DC Voltage: 3 V (25±2 deg.C)
3. Operating Temperature: -20 °C to +85 °C
4. Storage Temperature: -40 °C to +85 °C
5. Moisture Sensitivity Level: Level 3
6. ESD: 1A (Max. voltage: 499V) (HBM), M1 (Max. voltage: 100V) (MM)

RoHS Compliant
Lead free
Lead-free soldering

Electrostatic Sensitive Device (ESD)

B. ELECTRICAL CHARACTERISTICS:

Item		Unit	Min.	Typ.	Max.	Note	
Center Frequency		Fc	MHz	-	2605	-	
Insertion Loss	IL	2555 ~ 2575 MHz	dB	-	1.9	3.3	-
		2575 ~ 2635 MHz	dB	-	1.6	2.4	-
		2635 ~ 2655 MHz	dB	-	2.1	3.6	-
		2555 ~ 2575 MHz	dB	-	1.9	2.5	+23 ~ +27deg.C
		2575 ~ 2635 MHz	dB	-	1.6	2.1	+23 ~ +27deg.C
		2635 ~ 2655 MHz	dB	-	2.1	2.7	+23 ~ +27deg.C
Amplitude Ripple		2555 ~2655 MHz	dB _{p-p}	-	0.7	2.3	-
		2555 ~2655 MHz	dB _{p-p}	-	0.7	1.4	+23 ~ +27deg.C
VSWR		2555 ~2655 MHz	-	-	1.7	2.4	-
		2555 ~2655 MHz	-	-	1.7	2.4	+23 ~ +27deg.C
Attenuation (Reference level from 0 dB)							
10 ~ 960	MHz	dB	31	38	-	-	
1225 ~ 1559	MHz	dB	30	36	-	-	
1559 ~ 1606	MHz	dB	30	36	-	-	
1606 ~ 1710	MHz	dB	28	35	-	-	
1710 ~ 2170	MHz	dB	27	34	-	-	
2170 ~ 2400	MHz	dB	28	35	-	-	
2401 ~ 2438	MHz	dB	32	39	-	-	
2421 ~ 2483	MHz	dB	26	33	-	-	
2750 ~ 4900	MHz	dB	31	38	-	-	

4900 ~ 6000	MHz	dB	41	48	-	-
6000 ~ 8000	MHz	dB	48	55	-	-

C. MEASUREMENT CIRCUIT:

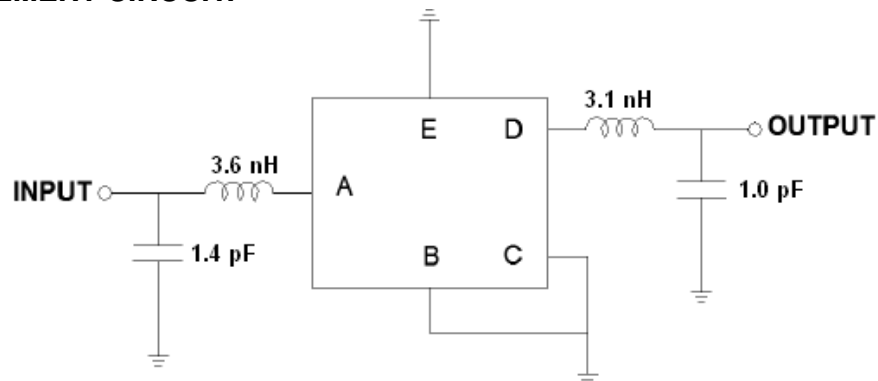

Source & Load Impedance: 50 Ω

D. OUTLINE DRAWING:

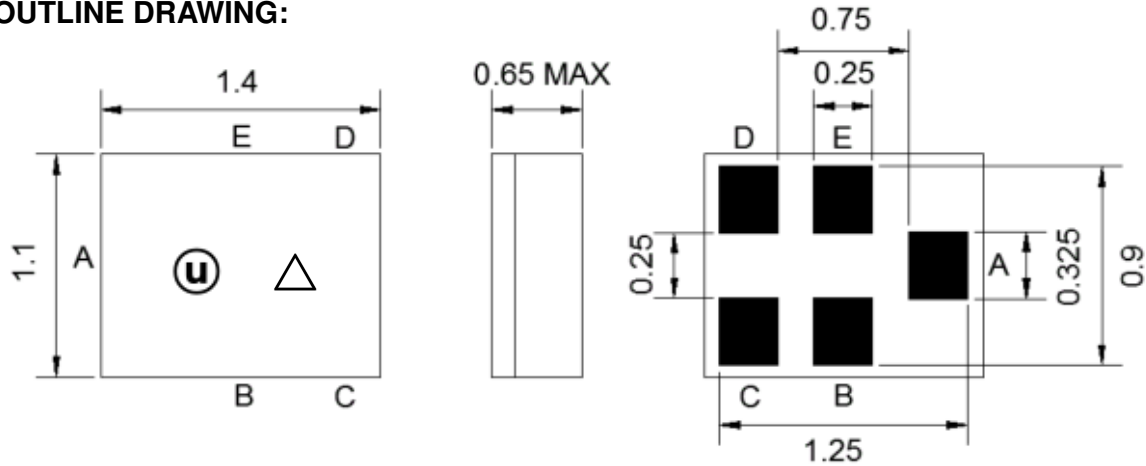

Marking Descriptions	
Ⓢ	Product symbol
△	Date Code (Year+Month)

Pin Description	
B, C, E	Ground
A	Input
D	Output

Date Code:

	Jan	Feb	Mar	Apr	May	Jun	Jul	Aug	Sep	Oct	Nov	Dec
2013	A	B	C	D	E	F	G	H	J	K	L	M
2014	N	P	Q	R	S	T	U	V	W	X	Y	Z
2015	a	b	c	d	e	f	g	h	j	k	l	m
2016	n	p	q	r	s	t	u	v	w	x	y	z
2017	A	B	C	D	E	F	G	H	J	K	L	M
2018	N	P	Q	R	S	T	U	V	W	X	Y	Z
2019	a	b	c	d	e	f	g	h	j	k	l	m
2020	n	p	q	r	s	t	u	v	w	x	y	z

E. PCB Footprint:

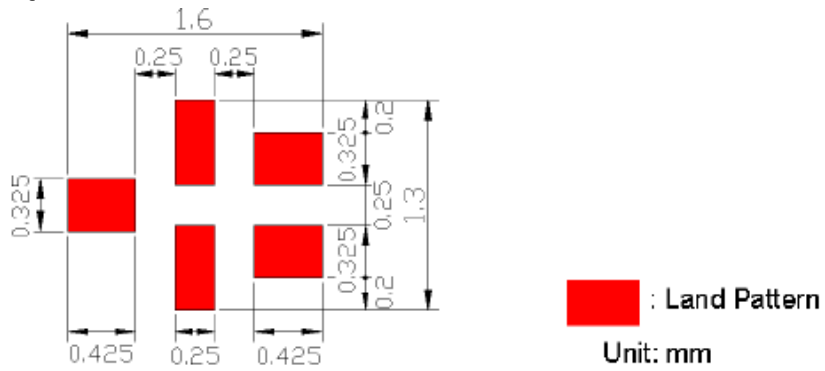

F. FREQUENCY CHARACTERISTICS:

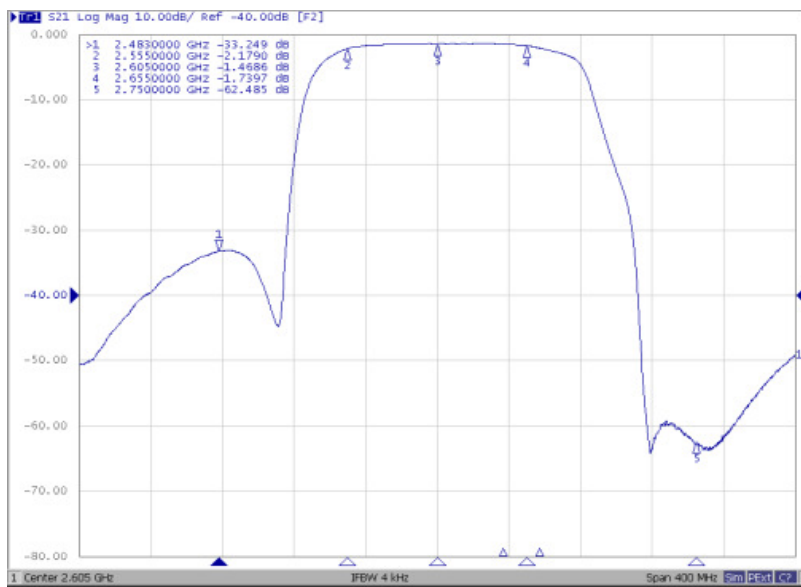
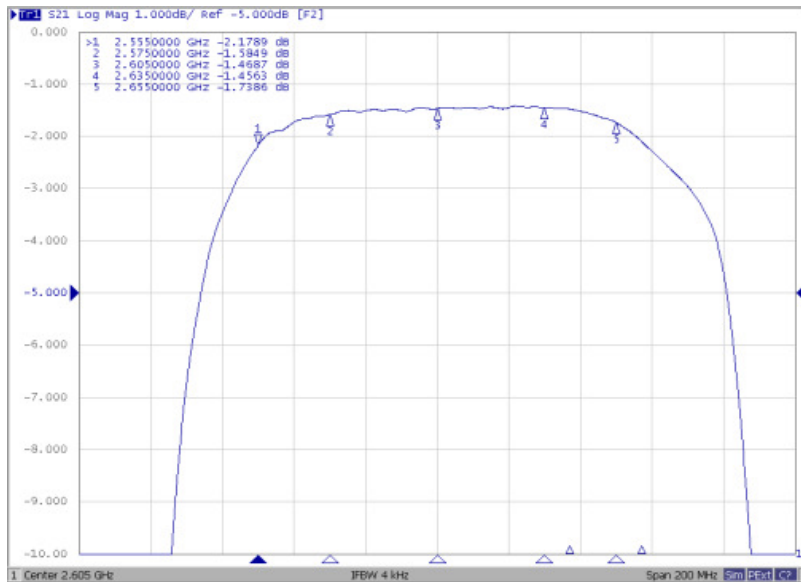



Reflection Functions:

S11

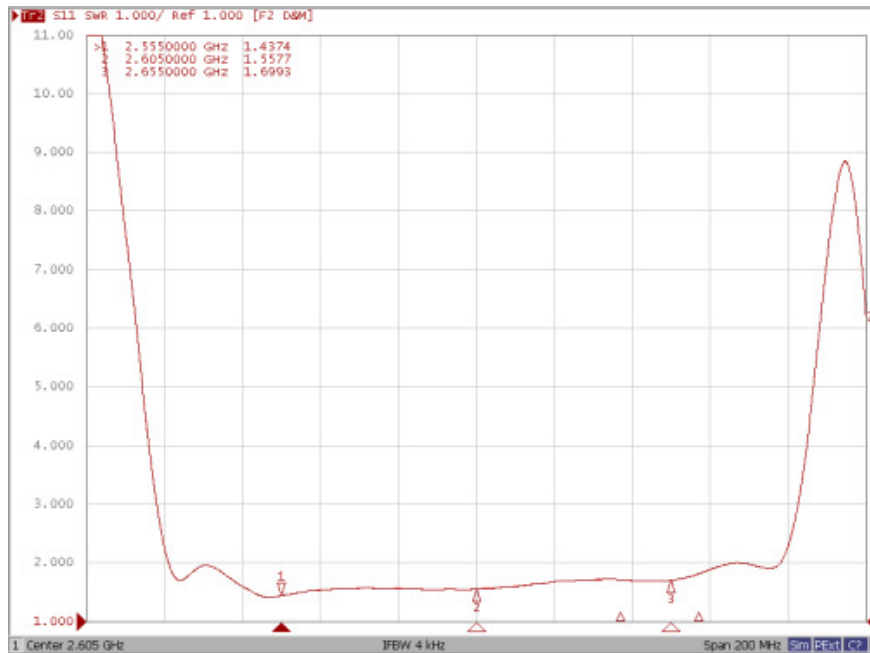

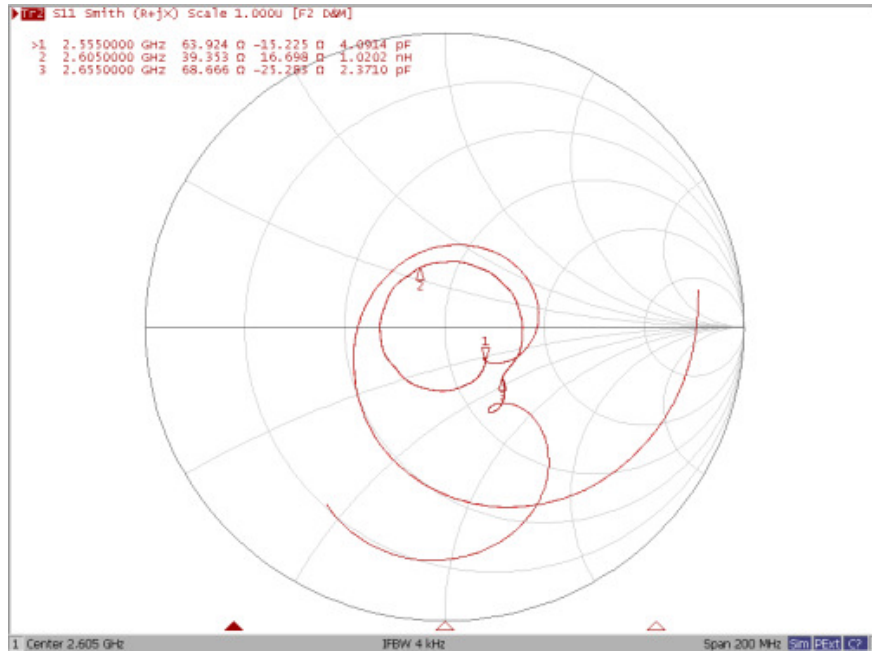

S22

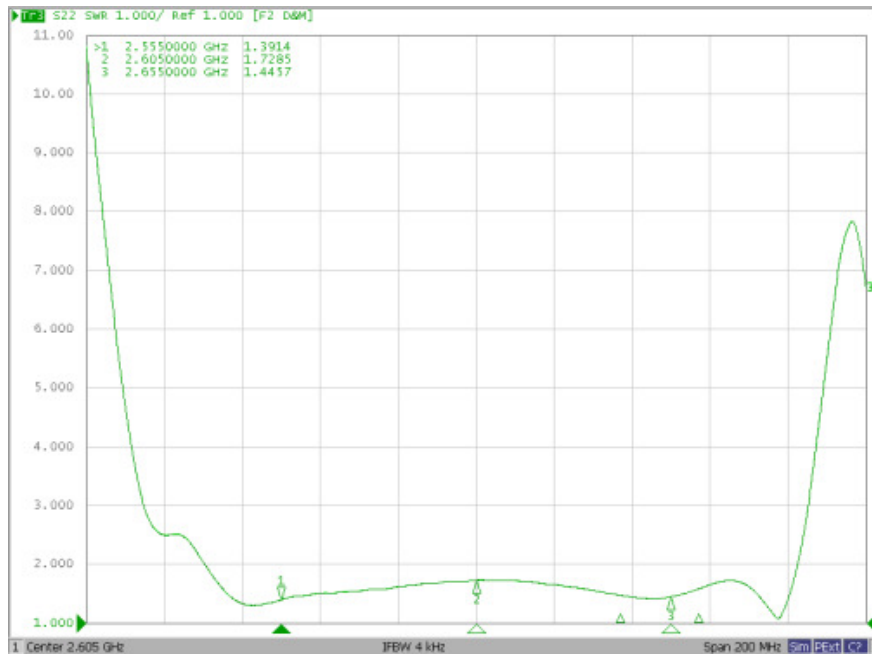

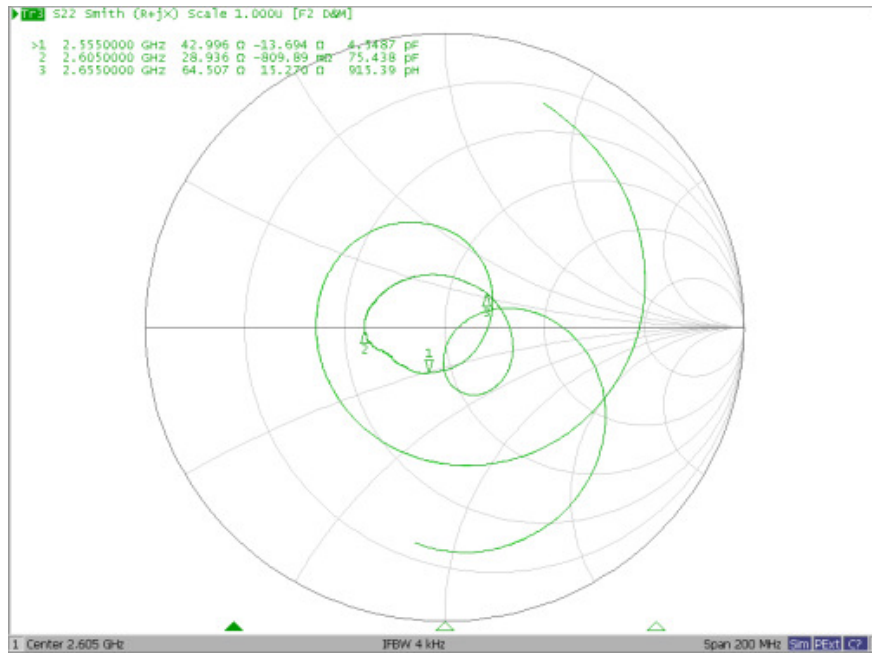

G. PACKING:
1. REEL DIMENSION

